

Section 4

Tubes & Accessories

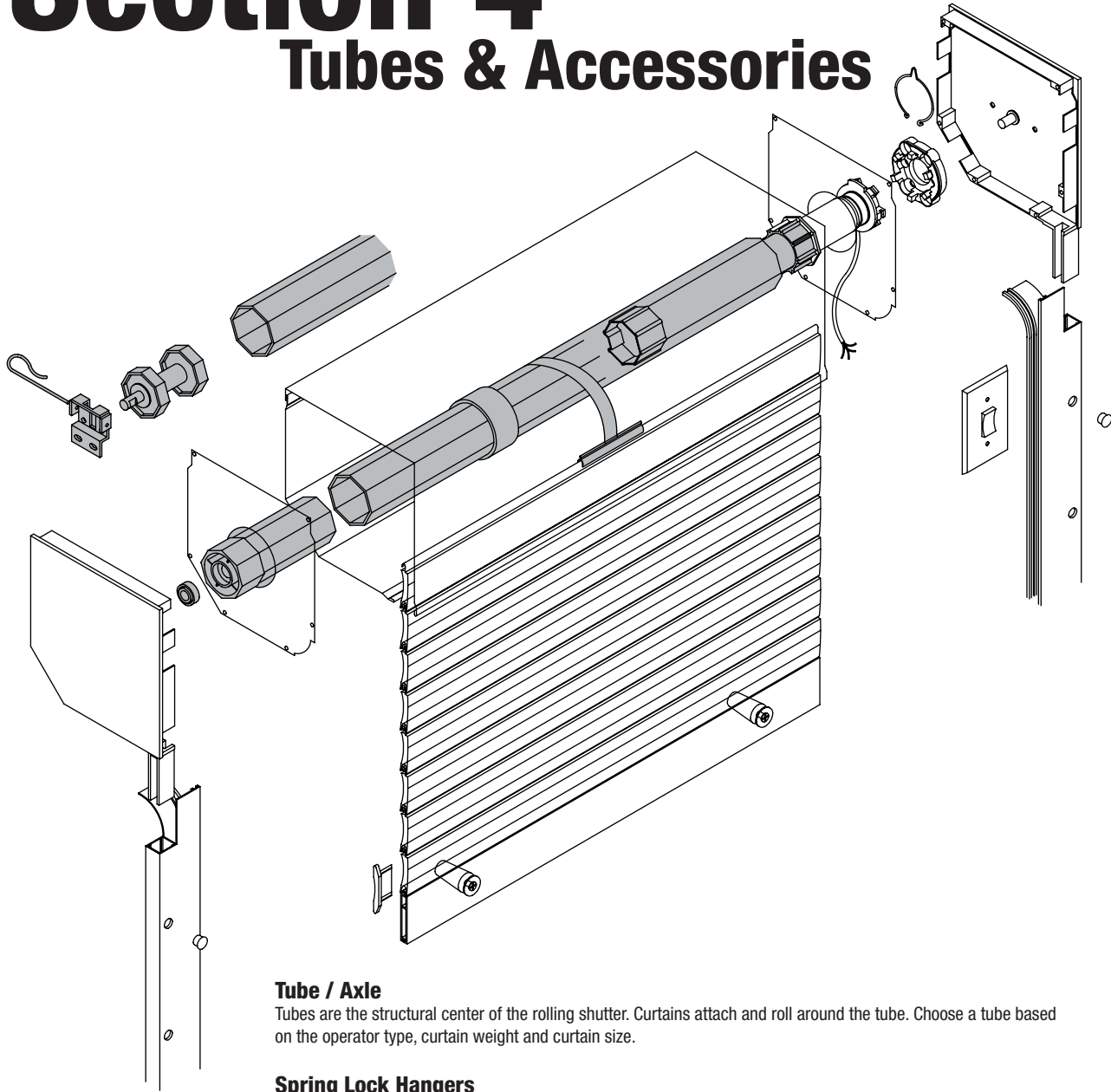

Tube / Axle

Tubes are the structural center of the rolling shutter. Curtains attach and roll around the tube. Choose a tube based on the operator type, curtain weight and curtain size.

Spring Lock Hangers

Spring lock hangers are used to secure the slats into a locking vertical position and attach the slat curtain with the axle. Slat type will determine the spring lock hanger used (mini / maxi slat).

Idlers / Caps

Idlers / caps are located on the inside of the axle on the opposite side of the operator. They assist in turning the axle. Type of idler is determined by the weight of shutter and size of axle.

Adapters

Adapters are rings on the outside of the axle that transition different axle diameters. This is accomplished by converting an octagonal receptor to a circular one. They also aide in maintaining uniform curtain roll up.

Mounting Plates / Brackets

Mounting plates / brackets are mounted to side caps and support the axle and operator. They also connect the axle / operator to the the side cap.

Bearings

Bearings are located inside the cap / idler and help turn the curtain. Bearing is determined by the type of cap used.

TUBES

Octagonal Tubes - Galvanized Steel

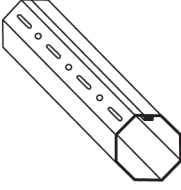
	Part Number	Description	Unit	Note
	4000-TUBE-00-ST	1.50"/40 mm O.D. x 0.6 mm Wall Thickness	FT	*
	4004-TUBE-00-ST	2.00"/50 mm O.D. x 0.6 mm Wall Thickness	FT	*
	4010-TUBE-00-ST	2.36"/60 mm O.D. x 0.6 mm Wall Thickness	FT	*
	4014-TUBE-00-ST	2.36"/60 mm O.D. x 0.9 mm Wall Thickness	FT	*
	4032-TUBE-00-ST	2.75"/70 mm O.D. x 1.2 mm Wall Thickness	FT	*
	4033-TUBE-00-ST	2.75"/70 mm O.D. x 1.5 mm Wall Thickness	FT	*
	4034-TUBE-00-ST	2.75"/70 mm O.D. x 0.9 mm Wall Thickness	FT	*
Available in 19' or 19.7' (5.8 or 6 meters) Special Order				

Octagonal Tubes - Aluminum

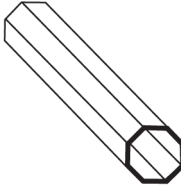
	Part Number	Description	Unit	Note
	4003-TUBE-00-AL	1.50"/40 mm O.D. x 1.3 mm Wall Thickness	FT	*
	4020-TUBE-00-AL	2.50"/60 mm O.D. x 2.4 mm Wall Thickness	FT	*
	4025-TUBE-00-AL	2.75"/70 mm O.D. x 3.0 mm Wall Thickness	FT	*
Available in 20 FT Lengths				

Round Tubes - Galvanized Steel

	Part Number	Description	Unit	Note
	4048-TUBE-00-ST	3.95"/100 mm O.D. x 2.0 mm Wall Thickness Available in 24 FT Lengths	FT	

Splicers / Extenders - Galvanized Steel (For Octagonal Tube)

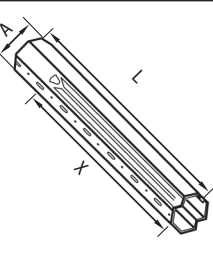
	Part Number	Description	Unit	Note
	4080-TUBE-00-ST	For 40 mm O.D. x 0.6 mm L = 400 mm X = 300 mm A = 38 mm	PC	
	4085-TUBE-00-ST	For 60 mm O.D. x 0.6 mm L = 500 mm X = 420 mm A = 58 mm	PC	

Aluminum Slat Hanger for Clear Lexan System

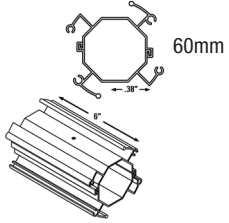
	Part Number	Description	Unit	Note
	1354-LOCK-00-AL	"Spider" Slat Hanger - 60 mm Octagonal Axle	PC	

* - Typically ships within 3 days
N - New item
! - Special order item

SPRING LOCK HANGERS

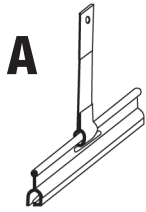

5.5" / 135 mm PVC - Coated Spring Steel (Aluminum Hook) Type "K"

Part Number	Description	Unit	Note
4100-LOCK-PL-ST	With Hole for Screw or Rivet (A)	PC	*
4101-LOCK-PL-ST	With Hole for Screw or Rivet & Hook (B)	PC	
4102-LOCK-PL-ST	With Hole for Screw (C) For Mini Slats, Used with Housing 7" or Smaller	PC	

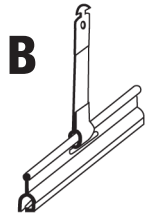

6.81" / 173 mm PVC-Coated Spring Steel (Aluminum Hook) Type "K"

Part Number	Description	Unit	Note
4110-LOCK-PL-ST	With Hole for Screw or Rivet (A)	PC	*
4111-LOCK-PL-ST	With Hole for Screw or Rivet & Hook (B)	PC	
4112-LOCK-PL-ST	With Hole for Screw (C) For Mini Slats, Used With Box Covers Larger Than 7"	PC	

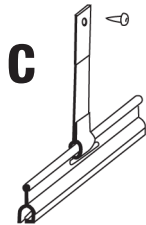

7.87" / 200 mm PVC - Coated Spring Steel (Aluminum Hook) Type "K"

Part Number	Description	Unit	Note
4161-LOCK-PL-ST	With Hole for Screw or Rivet; Hanger 100 mm wide (A)	PC	*
4165-LOCK-PL-ST	With Hole for Screw or Rivet EXTRA WIDE Hanger 150 mm wide (A)	PC	
4170-LOCK-PL-ST	With Hole for Screw or Rivet & Hook Hanger 100 mm wide (B)	PC	
4172-LOCK-PL-ST	With Split End Hook: Hanger 3.9"/100 mm Wide (E) For Maxi Slats, Used With Box Cover Larger Than 7"	PC	

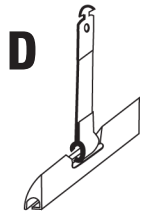

7.5" / 190mm Spring Steel (PVC Hook) Type "P"

Part Number	Description	Unit	Note
4171-LOCK-PL-ST	With Hole for Screw or Rivet & Hook (D) For Maxi Slats Used With Box Cover Larger Than 7"	PC	

TYPE 'K' = POLYESTER COATED, ABRASION SAFE

TYPE 'P' = SUSPENSION POLY-GLASS FIBER; SOLIDITY LIKE ALUMINUM & SCRATCH PROTECTION LIKE PVC

* - Typically ships within 3 days
N - New item
! - Special order item

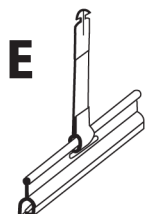

SAFETY BLOCKING DEVICE

Security Block Burglar Proof Fixation - For Maxi Profile

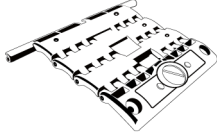
	Part Number	Description	Unit	Note
	4150-LOCK-PL-ST	w/quick Fixing (1 part, type 2)	PC	
4151-LOCK-PL-ST	w/quick Fixing (2 parts, type 2)	PC		
4152-LOCK-PL-ST	w/quick Fixing (3 parts, type 2)	PC		
4153-LOCK-PL-ST	w/Screw Cap (1 part)	PC		
4154-LOCK-PL-ST	w/fixation w/Screw cap - 2 parts	PC		
4155-LOCK-PL-ST	w/fixation w/Screw cap - 3 parts	PC		
4156-LOCK-00-PL	Maxi Profile for burglar proof fixation	PC		

Safety Blocking Device - For Mini Profiles

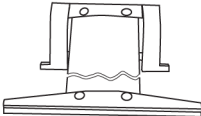
	Part Number	Description	Unit	Note
	4174-LOCK-PL-ST	75 mm for 40 mm Octagonal Tube	PC	
4175-LOCK-PL-ST	105 mm for 40 mm Octagonal Tube	PC		
4176-LOCK-PL-ST	75 mm for 50 mm Octagonal Tube	PC		
4177-LOCK-PL-ST	105 mm for 50 mm Octagonal Tube	PC		
4178-LOCK-PL-ST	135 mm for 50 mm Octagonal Tube	PC		
4189-LOCK-PL-ST	75 mm for 60 mm Octagonal Tube	PC		
4190-LOCK-PL-ST	105 mm for 60 mm Octagonal Tube	PC		
4191-LOCK-PL-ST	135 mm for 60 mm Octagonal Tube	PC		

Safety Blocking Device - For Maxi Profiles

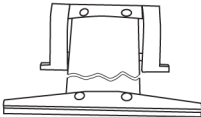
	Part Number	Description	Unit	Note
	4179-LOCK-PL-ST	105 mm for 50 mm Octagonal Tube	PC	
4180-LOCK-PL-ST	135 mm for 50 mm Octagonal Tube	PC		
4181-LOCK-PL-ST	165 mm for 50 mm Octagonal Tube	PC		
4182-LOCK-PL-ST	190 mm for 50 mm Octagonal Tube	PC		
4192-LOCK-PL-ST	105 mm for 60 mm Octagonal Tube	PC		
4193-LOCK-PL-ST	135 mm for 60 mm Octagonal Tube	PC		
4194-LOCK-PL-ST	165 mm for 60 mm Octagonal Tube	PC		

Backup Sleeve

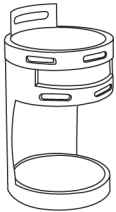
	Part Number	Description	Unit	Note
	4183-LOCK-PL-ST	For 60 mm Octagonal Tube	PC	

Security Blocking Device

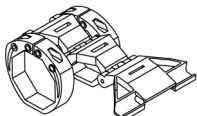
	Part Number	Description	Unit	Note
	4184-LOCK-PL-ST	Security Block 60-3 Limbs 14 mm (Maxi)	PC	
4185-LOCK-PL-ST	Security Block 60-4 Limbs 14 mm (Maxi)	PC		
4186-LOCK-PL-ST	Security Block 60-3 Limbs 9 mm (Mini)	PC		
4187-LOCK-PL-ST	Security Block 70- 3 Limbs 9 mm (Maxi)	PC		
4188-LOCK-PL-ST	Security Block 70- 4 Limbs 14 mm (Maxi)	PC		
		For 60 and 70 mm OCTAGONAL TUBE, Maxi and Mini Profile (Galvanized Only)		

* - Typically ships within 3 days
 N - New item
 ! - Special order item

IDLERS & CAPS

Idler (Mini PVC Cap)

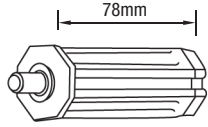
	Part Number	Description	Unit	Note
	4210-CAPS-00-PL	With 10 mm Steel Pivot - 78 mm Long For 40 mm Octagonal Tube	PC	

Idler (Mini PVC Cap)

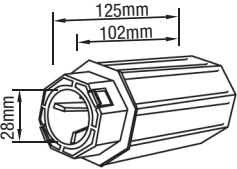
	Part Number	Description	Unit	Note
	4226-CAPS-00-PL	For 28 mm Ball Bearing (125 mm Long) For 50 mm Octagonal Tube	PC	

Idler (Mini PVC Cap)

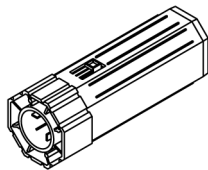
	Part Number	Description	Unit	Note
	4220-CAPS-00-PL	For 28 mm Ball Bearing - 78 mm Long	PC	
	4228-CAPS-00-PL	Cap w/Clips for 28 mm Ball Bearing	PC	
	4229-CAPS-00-PL	Cap w/Clips and 10 mm Square Hole	PC	
	4231-CAPS-00-PL (4228 SHOWN)	Cap w/Clips and 13 mm Square Hole For 50mm Octagonal Tube	PC	

Telescopic Cap for 28mm Ball Bearing

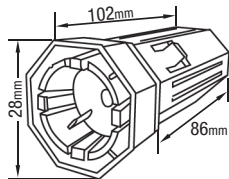
	Part Number	Description	Unit	Note
	4230-CAPS-00-PL	40mm Octagonal Tube (102 mm Long)	PC	
	4227-CAPS-00-PL	50mm Octagonal Tube (63 mm Long)	PC	
	4243-CAPS-00-PL (4230 SHOWN)	60mm Octagonal Tube (100 mm Long) For 28mm Ball Bearing	PC	

IDLERS & CAPS

Idler (PVC Cap)

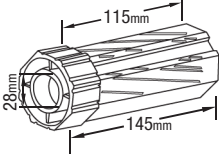
	Part Number	Description	Unit	Note
	4242-CAPS-00-PL	For 28 mm Ball Bearing - 145 mm Long	PC	*
		For 60 mm Octagonal Tube		

Idler (PVC Cap)

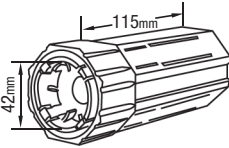
	Part Number	Description	Unit	Note
	4244-CAPS-00-PL	For 42 mm Ball Bearing - 55 mm Long	PC	
	4246-CAPS-00-PL (4246 SHOWN)	For 42 mm Ball Bearing - 115 mm Long		
		For 60 mm Octagonal Tube		

Idler (Mini Adaptor Cap)

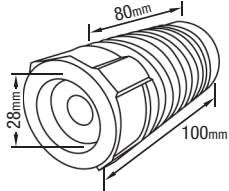
	Part Number	Description	Unit	Note
	4232-CAPS-00-PL	PVC For 28 mm Ball Bearing - 100 mm Long	PC	
	4233-CAPS-00-AL	ALU For 28 mm Ball Bearing - 100 mm Long		
		For 40 mm / 47 mm Round Tube		

Idler (PVC Cap)

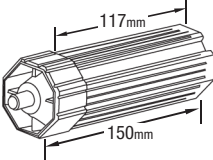
	Part Number	Description	Unit	Note
	4235-CAPS-00-PL	With 12 mm Steel Pivot - 55 mm Long	PC	
	4245-CAPS-00-PL (4245 SHOWN)	With 12 mm Steel Pivot - 150 mm Long		
		For 60 mm Octagonal Tube		

* - Typically ships within 3 days
 N - New item
 ! - Special order item

IDLERS & CAPS

Idler (Mini PVC Cap)

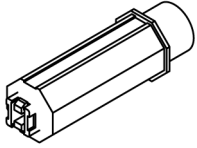
	Part Number	Description	Unit	Note
	4263-CAPS-00-PL	For 28 mm Ball Bearing (90 mm Long)	PC	
	4259-CAPS-00-PL	For 28 mm Ball Bearing (60 mm Long)		
	(4259 SHOWN)	For 40mm Octagonal Tube (Retractable Mini PVC Cap With Spring)		

Idler (Adaptor)

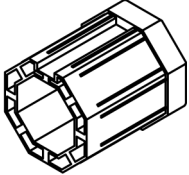
	Part Number	Description	Unit	Note
	4264-CAPS-00-PL	For use with #4263 For 40 mm to 60 mm	PC	

Idler (PVC Cap)

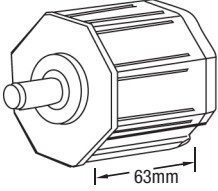
	Part Number	Description	Unit	Note
	4260-CAPS-00-PL	With 12 mm Steel Pivot (63 mm Long)	PC	
	4266-CAPS-00-PL	For 42 mm Ball Bearing (55 mm Long)	PC	
	(4260 SHOWN)	For 70 mm Octagonal Tube		

Idler (Alu Cap)

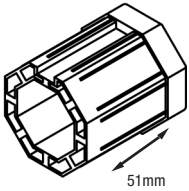
	Part Number	Description	Unit	Note
	4267-CAPS-00-AL	with 12 mm Alu Pivot For 70 mm Octagonal Tube	PC	

PVC Idler Cap

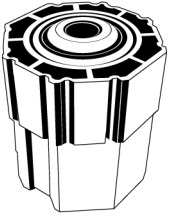
	Part Number	Description	Unit	Note
	4249-CAPS-00-PL	PVC idler cap for 60mm oct tube w/ 40mm ball bearing	PC	

* - Typically ships within 3 days
N - New item
! - Special order item

IDLERS & CAPS/COUPLERS

Idler Insert

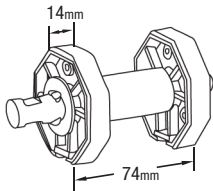
	Part Number	Description	Unit	Note
	4248-CAPS-00-PL	For 60 mm Octagonal Tube	PC	*
	4265-CAPS-00-PL (4248 SHOWN)	For 70 mm Octagonal Tube	PC	*
		Used with Idler-Bracket #5050		

Idler Inserts for Assist Springs

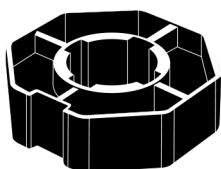
	Part Number	Description	Unit	Note
	4268-CAPS-00-PL	For 70 mm Octagonal	PC	N
	4269-CAPS-00-PL	For 70 mm Octagonal	PC	N
	4270-CAPS-00-PL (4268 SHOWN)	For 60 mm Octagonal		

Idler (PVC Cap)

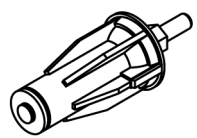
	Part Number	Description	Unit	Note
	4262-CAPS-00-PL	For Use With Bearing #5250 And Bearing Holder #5115 Adjustable Spring Loaded Idler 12 mm Pivot For Any Size Simu Or Somfy Crown And Drive	PC PC	

Axle Couplers

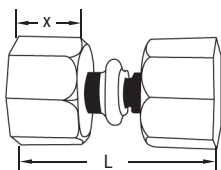
	Part Number	Description	Unit	Note
	4500-CAPS-00-ST	Galvanized - 130 mm Long 45mm Wide	PC	
	4505-CAPS-00-PL	PVC - 300 mm Long	PC	
	4506-CAPS-00-AL (4500 SHOWN)	Aluminum - 300 mm Long Double Cap For 60 mm Octagonal Tube With 42 mm Ball Bearing	PC	

Axle Couplers

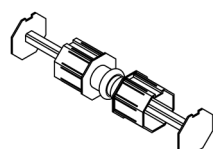
	Part Number	Description	Unit	Note
	4515-CAPS-00-PL	PVC - 300 mm Long	PC	
	4516-CAPS-00-AL (4515 SHOWN)	Aluminum - 300 mm Long Double Cap For 70mm Octagonal Tube With 42 mm Ball Bearing	PC	

* - Typically ships within 3 days
N - New item
! - Special order item

COUPLERS

Axle Couplers

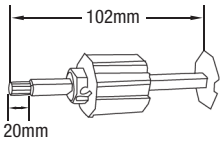
	Part Number	Description	Unit	Note
	4525-CAPS-00-PL	PVC for Bay Windows - 200 mm Long	PC	
	4526-CAPS-00-AL (4525 SHOWN)	Aluminum for Bay Windows - 200 mm Long For 60 mm Octagonal Tube With Adjustable Pivot 12mm	PC	

Axle Couplers

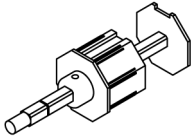
	Part Number	Description	Unit	Note
	4529-CAPS-00-PL	PVC for Bay Windows - 200 mm Long	PC	
	4530-CAPS-00-AL (4529 SHOWN)	Aluminum for Bay Windows - 200 mm Long For 70 mm Octagonal	PC	

Shaft Coupler

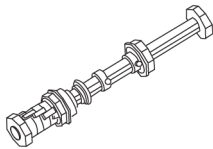
	Part Number	Description	Unit	Note
	8753-ACCE-00-XX	Shaft Coupler for Shutters with different Heights	PC	

* - Typically ships within 3 days
N - New item
! - Special order item

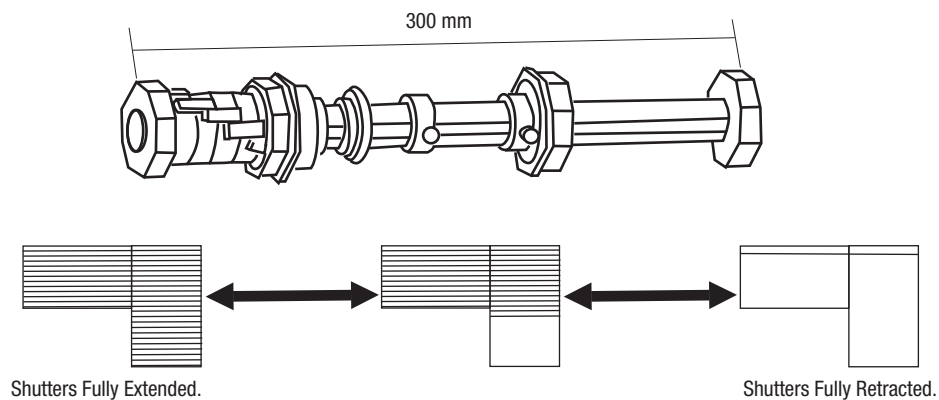

ADAPTERS

Axle Adaptors - Aluminum For Aluminum Axle

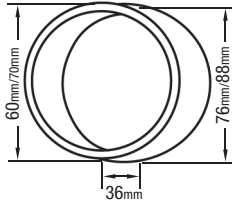
	Part Number	Description	Unit	Note
	4561 - CAPS-00 - AL	From 60 mm Octagonal Tube to 76 mm O.D. Round	PC	*
	4566 - CAPS-00 - AL (4561 SHOWN)	From 70 mm Octagonal Tube to 88 mm O.D. Round	PC	* *

Axle Adaptors - PVC For Galvanized Axle

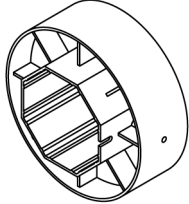
	Part Number	Description	Unit	Note
	4550 - CAPS-00 - PL	From 40 mm Octagonal Tube to 50 mm O.D. Round	PC	
	4560 - CAPS-00 - PL	From 60 mm Octagonal Tube to 80 mm O.D. Round	PC	
	4565 - CAPS-00 - PL	From 70 mm Octagonal Tube to 80 mm O.D. Round	PC	
	4570 - CAPS-00 - PL	From 70 mm Oct. Tube to 130 mm O.D. Round	PC	
	4571 - CAPS-00 - PL (4571 SHOWN)	From 70 mm Oct. Tube to 101mm O.D. Round	PC	*

Axle Adaptors - PVC

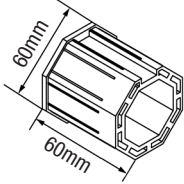
	Part Number	Description	Unit	Note
	4555 - CAPS-00 - PL	From 40 mm Octagonal Tube to 60 mm Octagonal	PC	

* - Typically ships within 3 days
 N - New item
 ! - Special order item

MOUNTING PLATES & BRACKETS

Mounting Plates & Brackets

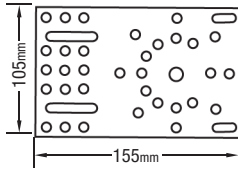
	Part Number	Description	Unit	Note
	5005-BRCK-00-ST	105 mm x 155 mm	PC	
	5010-BRCK-00-ST (5005 SHOWN)	105 mm x 200 mm Pre-Drilled Mounting Bracket	PC	

Angle Bracket

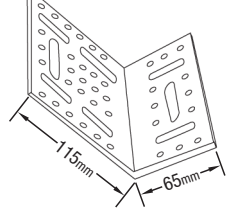
	Part Number	Description	Unit	Note
	5012-BRCK-00-ST	115 mm x 105 mm x 65 mm (Heavy Duty)	PC	
	5015-BRCK-00-ST (5012 SHOWN)	65 mm x 80 mm x 40 mm For Plate #5005 & #5010	PC	

Bolt / Nut / Washer

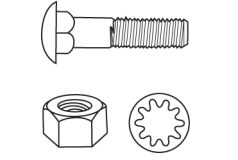
	Part Number	Description	Unit	Note
	5016-BOLT-00-ST	Bolt M6 x 15 mm (200/ Box) For Plate #5005, #5010, #5012 & #5015	PC	

Adjustable Angle Support

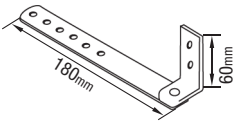
	Part Number	Description	Unit	Note
	5025-BRCK-00-ST	For Mounting Bracket #5005 & #5010	PC	

* - Typically ships within 3 days
 N - New item
 ! - Special order item

MOUNTING PLATES & BRACKETS

Mounting Plate & Bracket - Idler Support Bracket

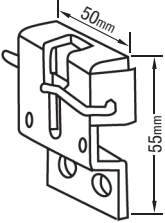
	Part Number	Description	Unit	Note
	5050-BRCK-00-ST	Mounting Bracket 55 mm x 50 mm (With Cotter Pin) For Idler #4248 & #4265	PC	*

Idler Support Plate For 10" and 12" 45° Sidecaps - Large Leg

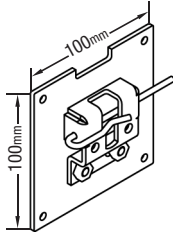
	Part Number	Description	Unit	Note
	5055-BRCK-00-ST	For 4248, 4265, & Springs 9618, 9622	PC	

Angle Bracket

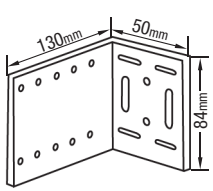
	Part Number	Description	Unit	Note
	5030-BRCK-00-ST	For Intermediate Support #5035	PC	

Intermediate Support

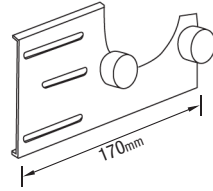
	Part Number	Description	Unit	Note
	5035-BRCK-00-ST	With Two Bearings, For #4560, #4561, #4565 & #4566	PC	

* - Typically ships within 3 days
 N - New item
 ! - Special order item

MOUNTING PLATES & BRACKETS

Plate For Standard Side Cap w/ 12 mm Pivot

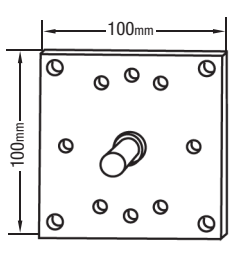
	Part Number	Description	Unit	Note
	5062-BRCK-00-ST	100 mm x 100 mm mounting bracket	PC	

For Strap Reduction Gears #7305 & #7310 / Any Bearing With a 12 mm Hole

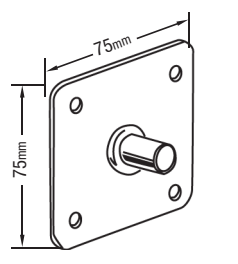
	Part Number	Description	Unit	Note
	5060-BRCK-00-ST	For Idlers With 12 mm Pivot	PC	

Angle Bracket 12" X 10" X 3.25"

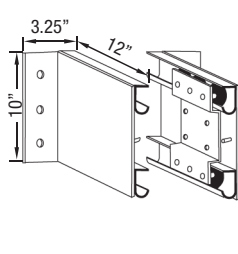
	Part Number	Description	Unit	Note
	5065-BRCK-00-ST	Rolling Bracket (Floating)	PC	

Rolling Bracket (Floating)

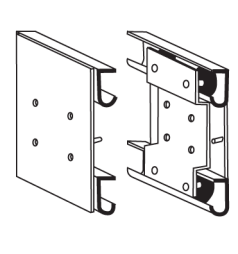
	Part Number	Description	Unit	Note
	5070-BRCK-00-ST	For BK-250S (10"/250 mm) Side Caps	PR	
	5075-BRCK-00-ST (5070 SHOWN)	For BK-300S (12"/300 mm) Side Caps	PR	

* - Typically ships within 3 days
 N - New item
 ! - Special order item

BEARING HOLDERS

Ball Bearing Holders

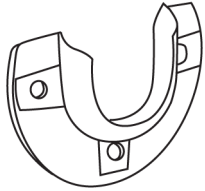
	Part Number	Description	Unit	Note
	5115-BEAR-00-ST	For 42 mm Ball Bearing, Galvanized Steel	PC	

Support with Bearing Holder

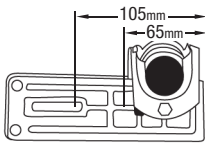
	Part Number	Description	Unit	Note
	5135-BEAR-00-ST	For 42 mm Ball Bearing, Galvanized Steel	PC	

Ball Bearing Holder

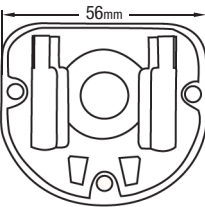
	Part Number	Description	Unit	Note
	5140-BEAR-00-ST	To Secure Bearing, Galvanized Steel For 42 mm Ball Bearing with Locking Tops	PC	

Ball Bearing Holder

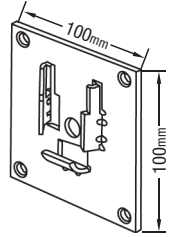
	Part Number	Description	Unit	Note
	5150-BEAR-00-ST 5151-BEAR-00-ST (5150 SHOWN)	Bend "Ears" Used With 42 mm Ball Bearing Plate 100 mm x 100 mm w/ Three Support Spec	PC PC	

* - Typically ships within 3 days
N - New item
! - Special order item

BEARINGS

Ball Bearings (Mini)

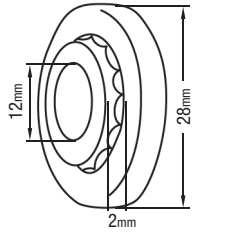
	Part Number	Description	Unit	Note
	5200-BEAR-00-ST	With Nylon Bushing for 12 mm Pivot	PC	*
5205-BEAR-00-ST	With Steel Bushing for 12 mm Pivot	PC		

Ball Bearings (Maxi)

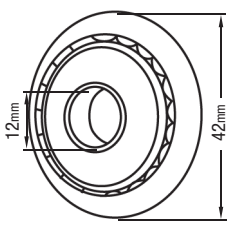
	Part Number	Description	Unit	Note
	5245-BEAR-00-ST	42 mm OD with Steel Bushing For 12 mm Pivot	PC	

Ball Bearings (Maxi)

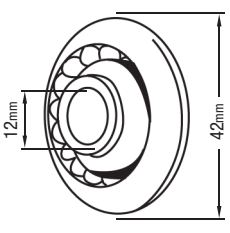
	Part Number	Description	Unit	Note
	5250-BEAR-00-ST	42 mm OD with Nylon Bushing For 12 mm Pivot	PC	

Ball Bearings (Maxi)

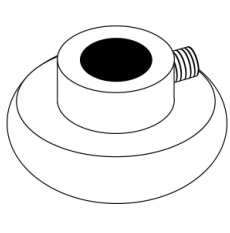
	Part Number	Description	Unit	Note
	5260-BEAR-00-ST	42 mm OD High Precision Stainless Steel Bearing 42mm F/13mm	PC	N

Ball Bearings (Maxi)

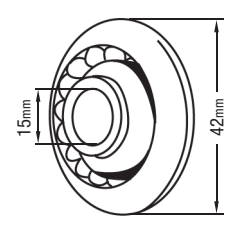
	Part Number	Description	Unit	Note
	5255-BEAR-00-ST	42 mm OD with Nylon Bushing For 15 mm Pivot	PC	

* - Typically ships within 3 days
 N - New item
 ! - Special order item